



IEA HPT Annex 49

Vögelebichl Innsbruck – Monitoring and simulation of two multi-family houses with heat pump, PV and collectors

Fabian Ochs, Georgios Dermentzis,
Alexandra Ksiezzyk

Rotterdam

15.05.2016



Part 1: NZEB project and concept

Project Vögelebichl (IBK, AT):

NZEB Project:

Two MFHs in PH standard with 26 dwellings from NHT (social housing company, Tyrol, Austria)

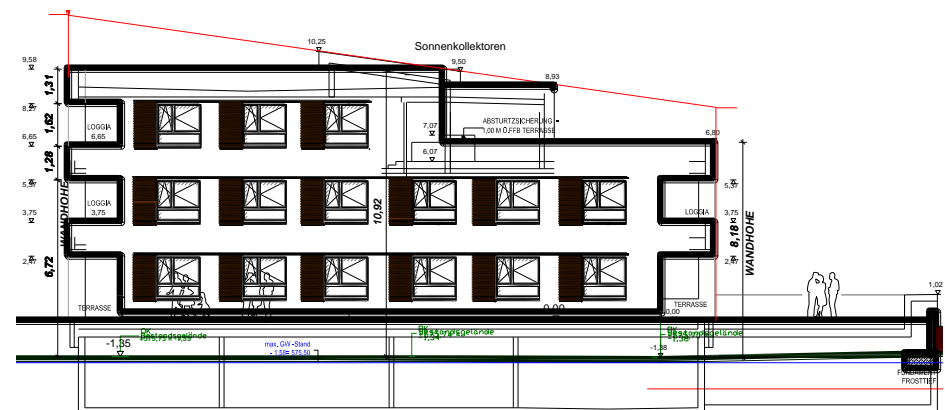
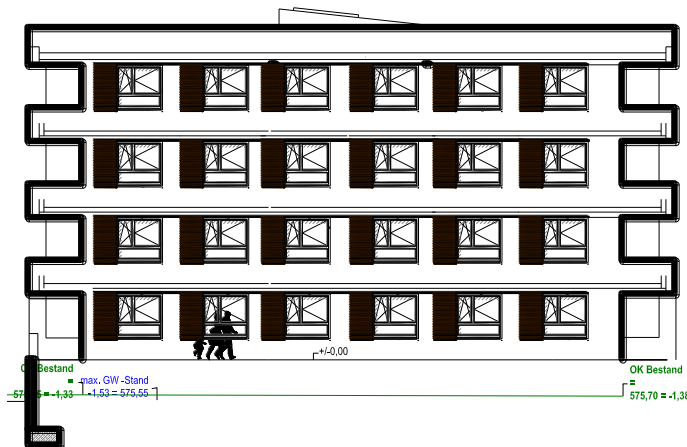

West view of the two multi-family houses in Innsbruck Vögelebichl, NHT Tirol

Project Vögelebichl (IBK, AT):

Multi-Family Passive Houses

- with ground water heat pump and PV (and opt. ST)
- with 4 pipe distribution system: low temperature system and fresh water HX in each flat

PHPP Energy Balance Calculation (Design)

	North	South
Flats	16	10
Persons	2.5 Persons/flat	
Treated Area	1269.8 m ²	818.8 m ²
Heating Demand	13.5 kWh/(m ² a)	17.0 kWh/(m ² a)
Heating Load	12.0 W/m ²	13.9 W/m ²
DHW	25l/d/P @ 60 °C	
PV	variable	16 kWp

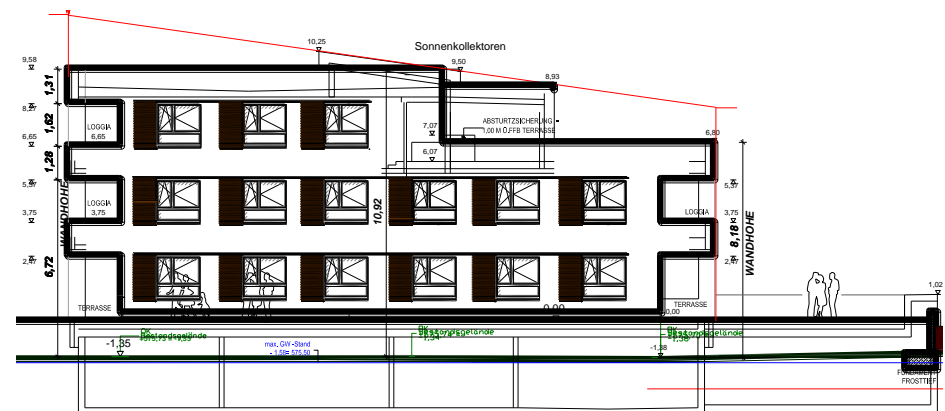
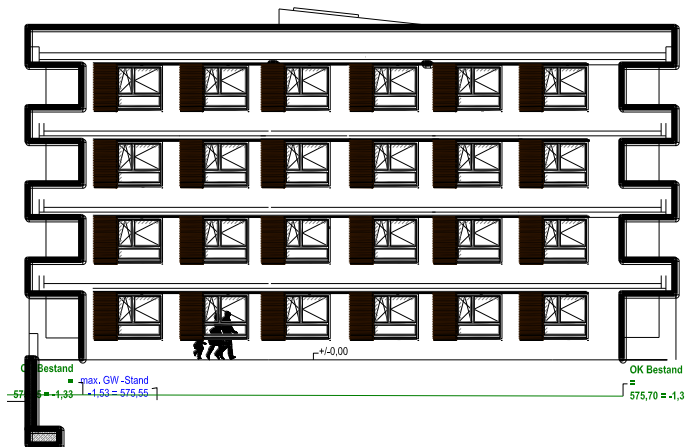

West view of the two multi-family houses in Innsbruck Vögelebichl, NHT Tirol

Definitions

nZEB: nearly zero Energy Building (EPBD, national definition)

NZEB: Net Zero Energy Building

here: Net Zero for

- Heating
- DHW
- Aux. Energies (MVHR, pumps, control, etc.)

No appliances



„net-zero“ as a goal is a misleading concept

	areas	Energy demand kWh / m ² _{TFA} a	65% roof area with PV	Net-zero?
<p>© PHI</p>	<p>TFA = 80 m²</p> <p>footprint =100 m²</p>	<p><u>Passive House!</u></p> <p>final energy 35</p> <p>for all consumers</p>	<p>7000 kWh/a</p> <p>250% of demand</p>	
<p>© PHI</p>	<p>TFA = 3x80 m²</p> <p>footprint =100 m²</p>	<p>for all consumers</p>	<p>7000 kWh/a</p> <p>83% of demand</p>	

MISGUIDING!

Goal

- Reduce CO₂ emissions
- Minimize Winter non-RE primary energy use

⇒ Efficiency + RE



Part 2: Design Optimization

Electricity demand for GW heat pump and auxiliary energy and PV yield

as a function of the size of the solar thermal system
(100 % corresponds to 140 m²).

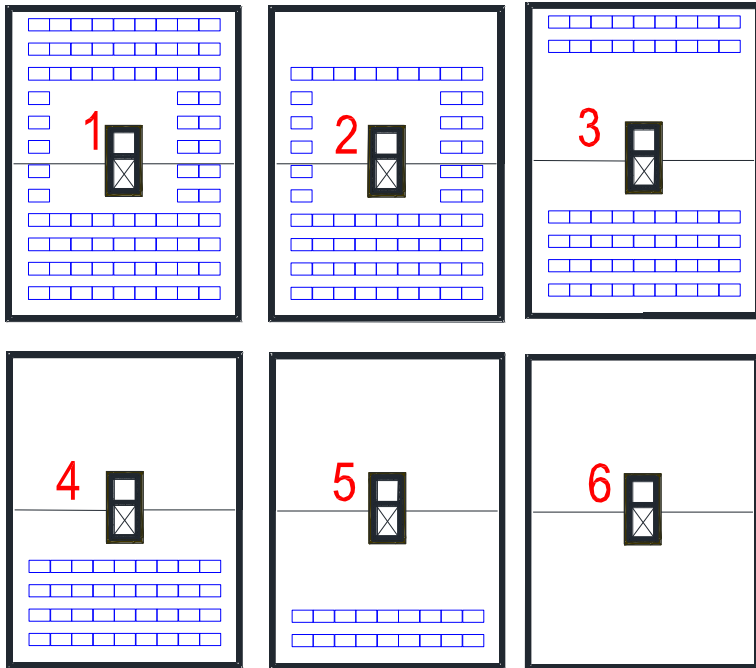

PV system size

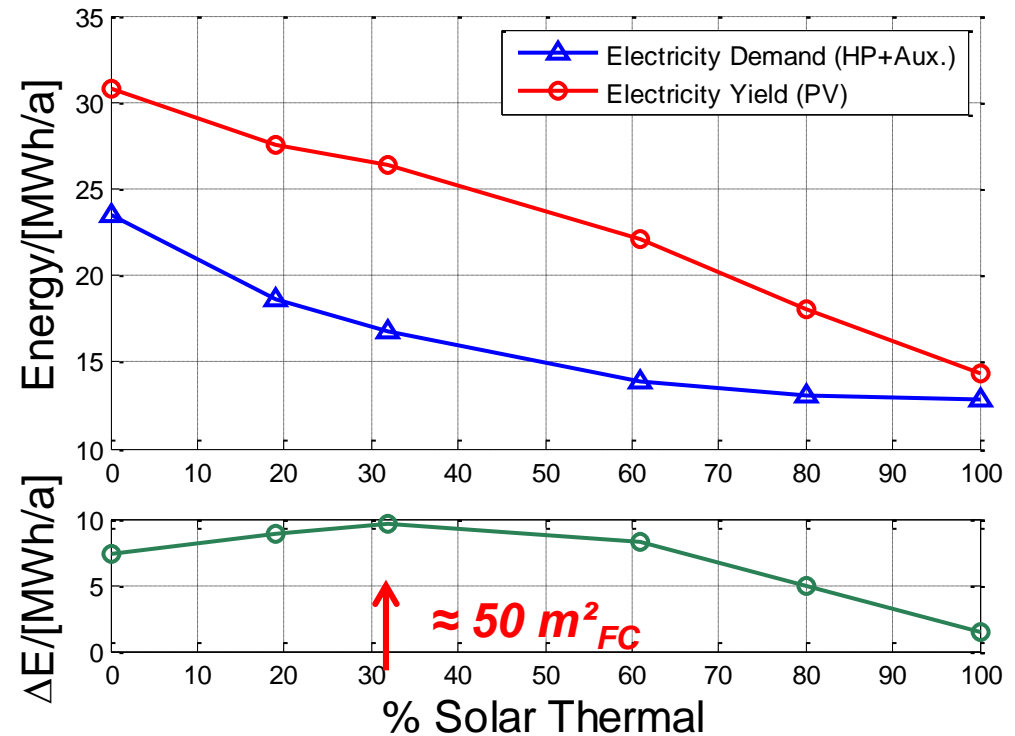

Electricity Demand and PV yield

Part 3: Monitoring Results (preliminary)

Project Data (as built)

- Treated area: 1295.6 m² (North) + 853.2 m² (South)
- ST area: 73.6 m² (North)
- PV area: 52.5 m² (North) + 99.8 m² (South)
- Double stage GW HP
- Buffer Storage: 6 m³
- Floor heating Flow temperature 35 °C
- DHW flow temperature 55 °C



Solar and Heat Pump System, Hydraulic Scheme

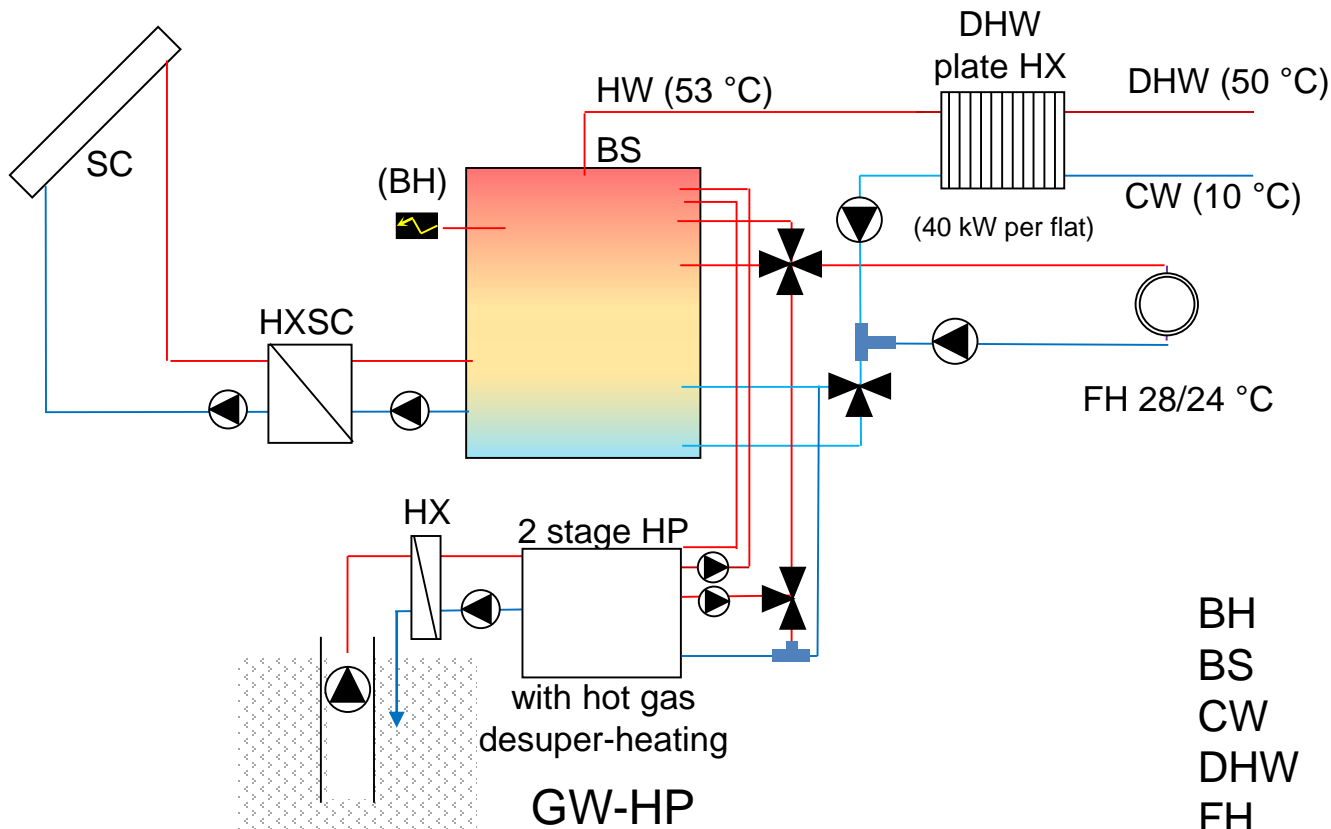

BH	Backup heater
BS	Buffer storage
CW	Cold water
DHW	Domestic hot water
FH	Floor Heating
GW	Ground water
HP	Heat Pump
HW	Hot water
HX	Heat Exchanger
SC	Solar collector

Net Balance

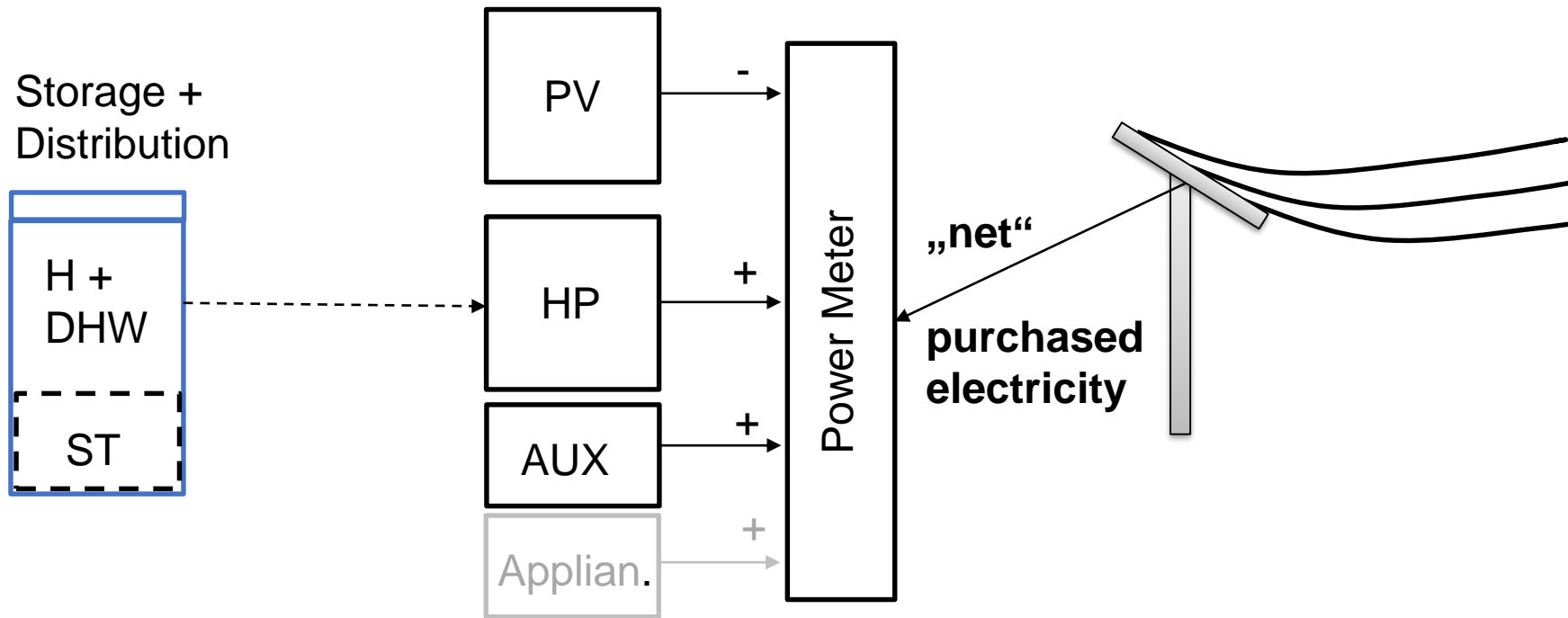

Prelim. Monitoring Results – Thermal Energy Balance

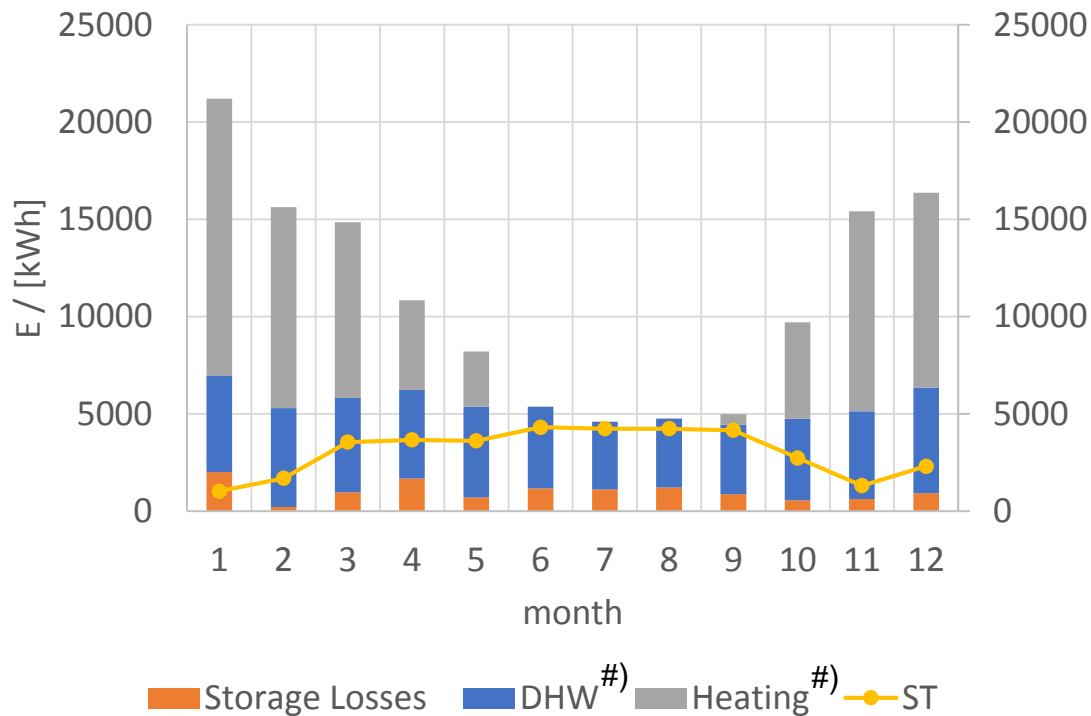

#) measured at storage outlet, includes distribution losses

- HD 31.1 kWh/(m² a) higher than design (PH) – first year: construction moisture, ...
- Deviation from design due to
 - User (set point, window ventilation, shading)
 - Climate
 - Construction (?)
- DWH with 24.7 kWh/(m² a) slightly higher than the design value
- ST covers summer load including losses

Prelim. Monitoring Results – Performance of HP

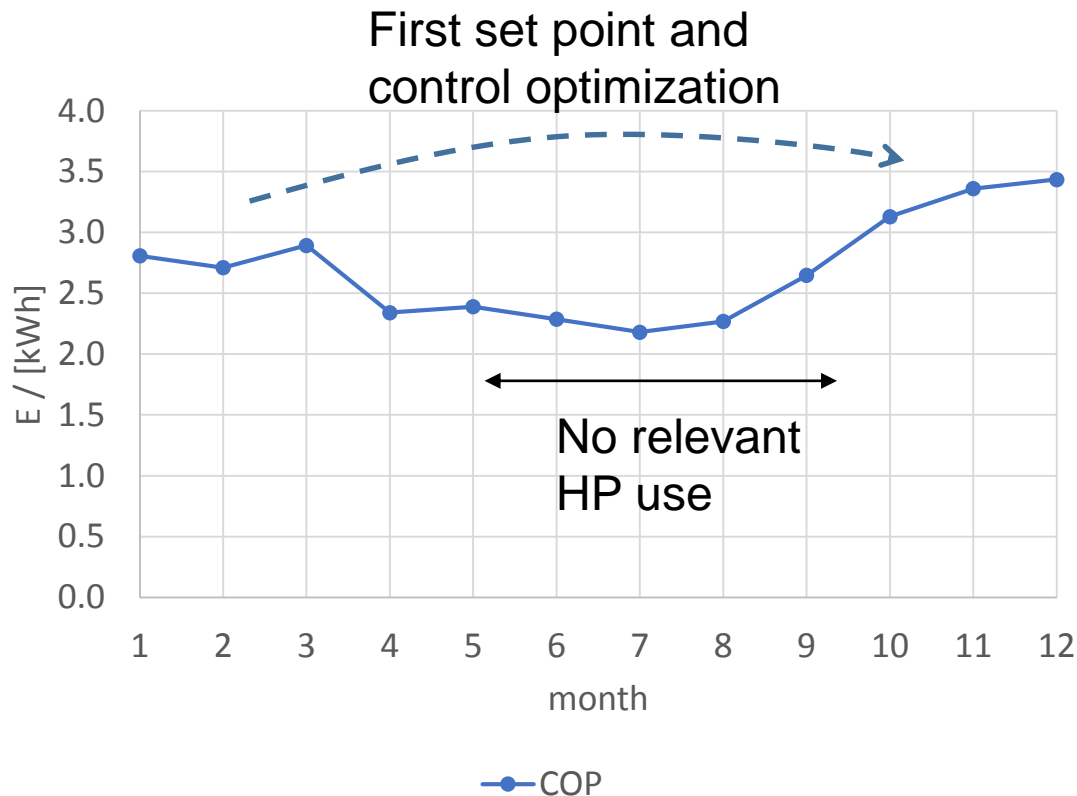

Average sCOP 2.9

HP operation not optimal

- Heating, DHW flow/return temperatures
- Storage stratification (HP set point temperature)
- Operation in summer

Control optimized,
Improved sCOP expected for
2017

Prelim. Monitoring Results – Performance of PV and ST

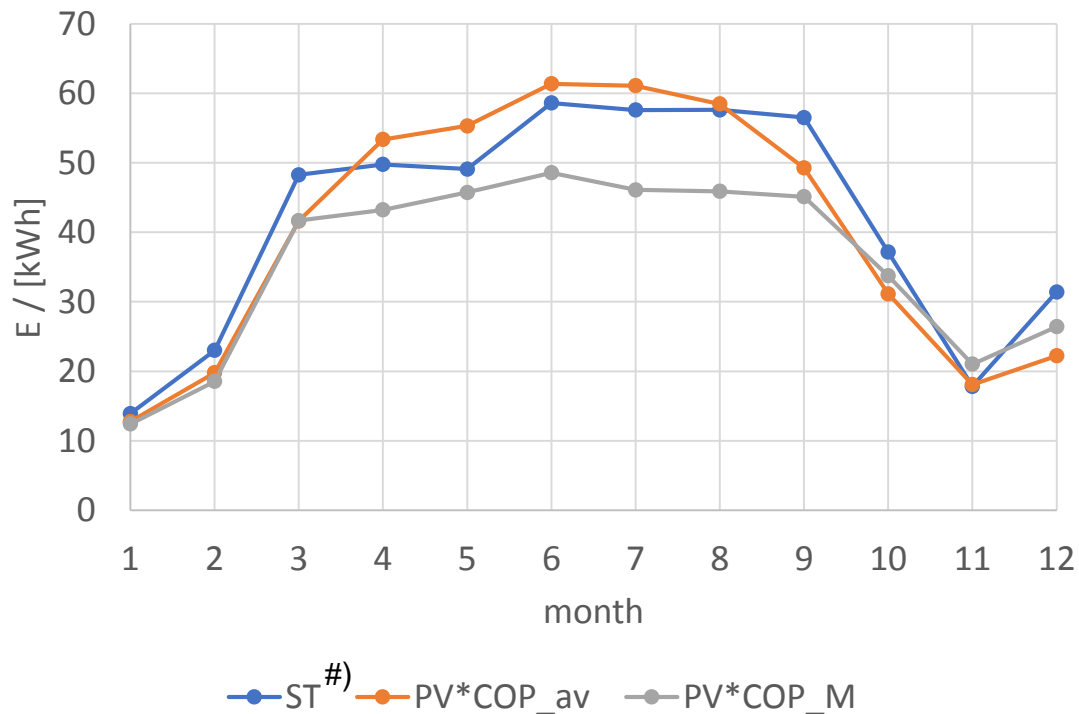

#) exludes storage losses

Good performance of
ST and PV:

$$q_{ST} = 500.8 \text{ kWh}/(\text{m}^2 a_{ST})$$

$$q_{ST-loss} = 336.5 \text{ kWh}/(\text{m}^2 a_{ST})$$

$$q_{PV(COP_{av})} = 484.5 \text{ kWh}/(\text{m}^2 a_{ST})$$

$$q_{PV(COP_M)} = 428.5 \text{ kWh}/(\text{m}^2 a_{ST})$$

Remark:

- All storage losses assigned to ST?
- PV „grid as short term storage for free“?

Prelim. Monitoring Results – EI. Energy Balance

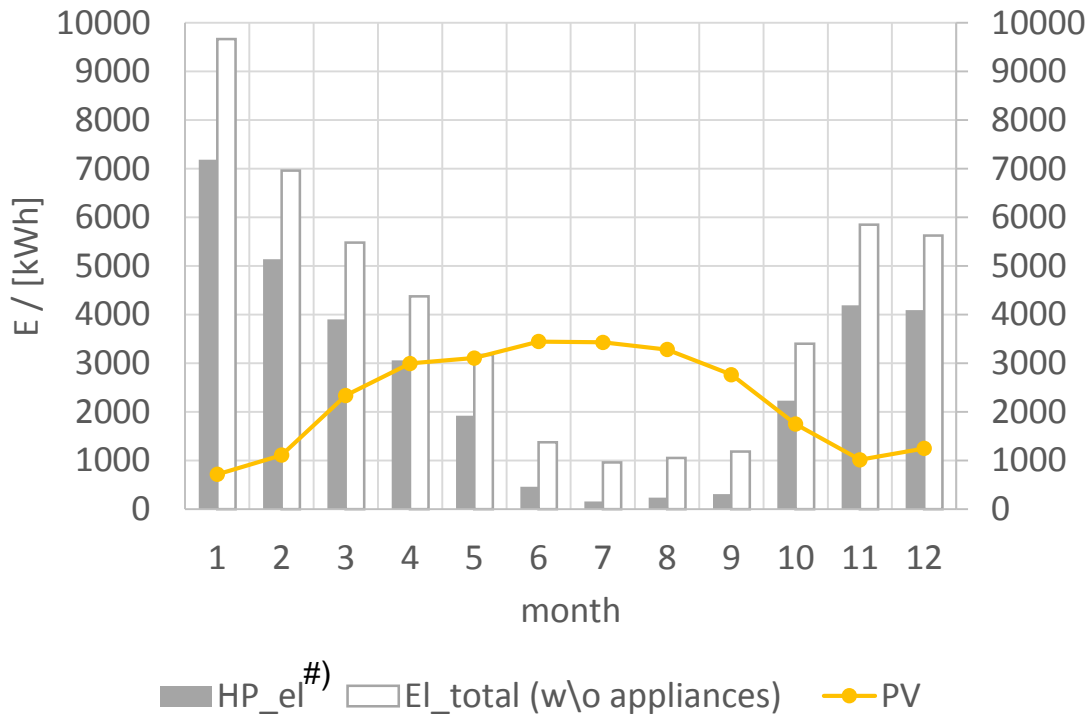

#) including well pump

NZEB not achieved in 2016

Aux. energies (pumps, MVHR, control, etc.) rel. high

PV yield is $167.6 \text{ kWh}/(\text{m}^2_{\text{PV}} \text{ a})$
or $27 \text{ kWh}/(\text{m}^2_{\text{AT}} \text{ a})$

Electricity consumption is
 $33 \text{ kWh}/(\text{m}^2 \text{ a})$ w/o aux. and
 $49 \text{ kWh}/(\text{m}^2)$ w\ aux.

Prediction ... optimized operation

EI. Energy Balance

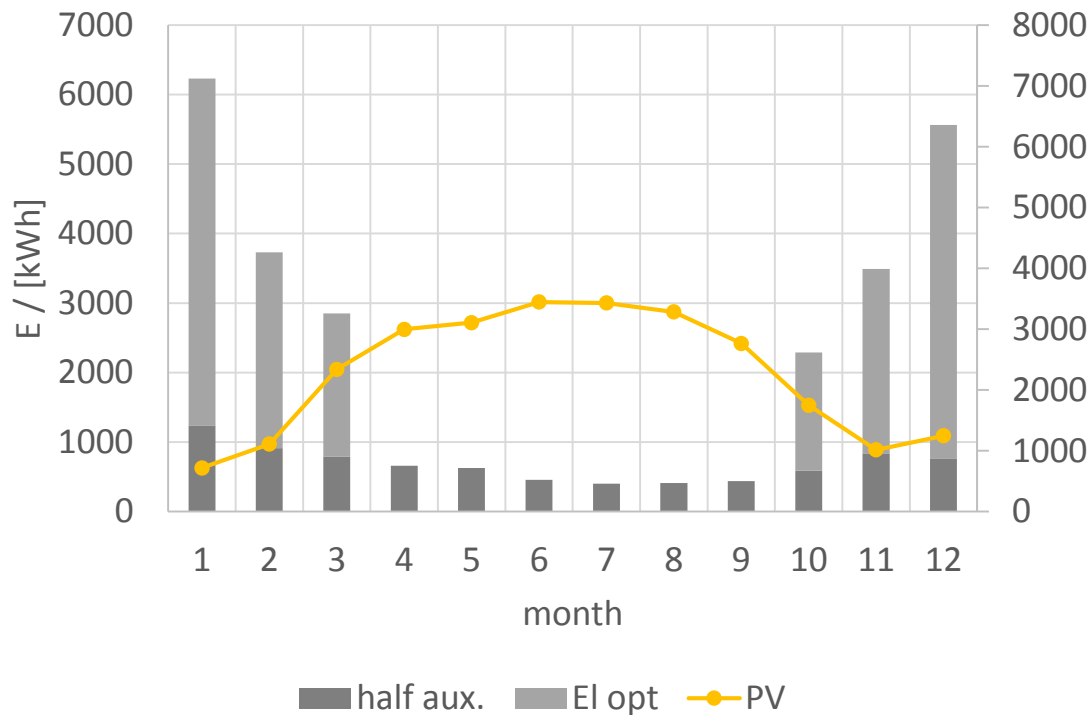

PV yield is $167.6 \text{ kWh}/(\text{m}^2_{\text{PV}} \text{ a})$
or $27 \text{ kWh}/(\text{m}^2_{\text{AT}} \text{ a})$

With PH, reduced storage losses, optimized control (improved HP) and reduced aux. Energies NZEB could be achieved

$$27 \text{ kWh}/(\text{m}^2 \text{ a}) = 27 \text{ kWh}/(\text{m}^2 \text{ a})$$

Prediction ... optimized operation

EI. Energy Balance

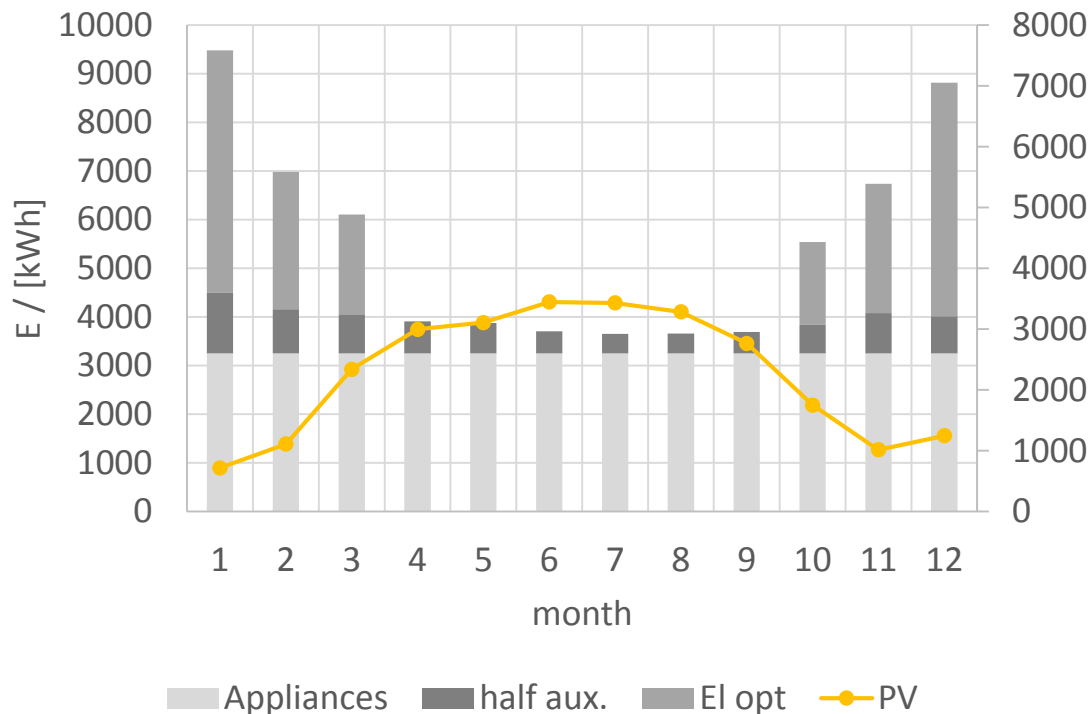

$27 \text{ kWh}/(\text{m}^2 \text{ a}) \neq 27 \text{ kWh}/(\text{m}^2 \text{ a}) + 39 \text{ kWh}/(\text{m}^2 \text{ a})$

PV yield is $167.6 \text{ kWh}/(\text{m}^2_{\text{PV}} \text{ a})$
or $27 \text{ kWh}/(\text{m}^2_{\text{AT}} \text{ a})$

With PH, reduced storage losses, optimized control (improved HP) and reduced aux. Energies NZEB could be achieved

Annual PV yield is even not enough to cover appliances (net balance), assuming $1500 \text{ kWh}/\text{a}$ per household

(appliances are not measured)

Summary and Conclusions

NHT Vögelebichl:

- MFH PH with solar and HP system and PV (to achieve NZE)
- Optimization of system design (share of ST, PV) by means of simulation
- ST theoretically with energetic benefits (in case of relatively small system size $f_{\text{sol,DHW}} < 40\%$)
- Good performance of ST and PV
- First yr. of operation cannot be used for analysis because of construction moisture, control optimization, etc.
- Preliminary results show that NZEB can be achieved, thermal losses (storage losses 10 %) and aux. energies must be reduced

Summary and Conclusions

NZEB general:

- NZEB concept can be misleading, instead objective must be minimum CO₂ emissions/non-RE PE consumption
- ... appliances must be considered
- PH standard is crucial for achieving NZEB,
- mismatch between (electricity) demand and PV yield can be considered by means of monthly PE factors and/or seasonal electricity prices (purchase and sell)

- KISS ...

... thanks!

Acknowledgement: This project is financially supported by NHT Tirol, Innsbruck, Austria. Building design optimization, PHPP calculations and PH certification was done by PHI Innsbruck.